



TECHNISTRUT

STRUT PRODUCTS

PRODUCT CATALOGUE - 2024

TECHNISTRUT – WHO WE ARE

Our Mission:

Providing high-quality Canadian made products that enhance each project they are a part of.

Our Vision:

Our vision at Technistrut is to empower builders, engineers, and local communities by providing reliable strut and strut fitting solutions. We do this by using high-quality Canadian sourced, and Canadian made metals and closely collaborating with our clients to fulfill each of their unique needs. Technistrut offers an extensive line of products, operates with a customer-first attitude, and has short turnaround times, which gives us the advantage we need to help our clients succeed.

Technistrut Ethos:

At Technistrut we believe in genuine service and taking ownership of what we do. We refuse to compromise on quality and strive to provide world-class levels of customer service. Our foundation is built on clear communication, flexibility, and continual improvement philosophies.

What do we offer?

We take pride in offering a comprehensive line of products that can meet the diverse needs of our customers. From standard strut fittings to specialized components we provide a wide range of Canadian made high-quality products designed to enhance structural support across a wide range of applications. Our catalogue includes a variety of strut fittings, brackets, post bases, strut clamps, pipe clips, pipe straps, washers etc. that are built to meet or exceed industry standards.

Moreover, we offer custom fabrication services, allowing us to create tailored products that are built to satisfy the unique needs of all our clients. Whether it is a specific size, thickness, hole size, spacing, material, or finish our team is dedicated to delivering what you need, how you need it.

Want to get in touch?

Let's talk about what Technistrut can do for you!

Phone: (519)-698-9856

Email: Sales@technistrut.ca

Website: www.Technistrut.ca



**TECHNISTRUT MFG INC.
4145 LAWSON LINE
POSTAL CODE: N0B 2S0
PHONE: 519-698-9856**

The specifications in this document are for reference only and are subject to change without prior notice.

TABLE OF CONTENTS

Table of Contents

Washer Product Variables	5
Strut Washers (T1001-T1016) (Pic with 9/16" hole).....	5
Square Washers (T1121 – T1148) (Pics with 9/16" Hole)	6
No Twist Strut Washers (T1201-T1205) (Pics with 9/16" Hole).....	7
U-Washer (T1303) (Pic with 9/16" Hole)	7
Pipe & Conduit Support Product Variables	8
Strut Clamps – Rigid (T2000-2008)	8
Strut Clamps – Thin Wall & OD (T2010-2028)	9
Pipe Block and Pipe Straps (T2100-2208)	10
Cable Clamps and Clevis Hangers (T2300-T2400).....	11
General Fitting Product Variables	12
90 Degree Fittings (T3012-T3092)	12
Angular Fittings (T3102-T3134).....	15
End Caps for Strut (T3200-T3210).....	16
Flat Plate Fittings (T3302-T3380).....	17
Flat Plate Fittings Continued (T3302-T3380)	18
U-Fittings (T3402-T3480)	19
U-Fittings Continued (T3400-T3480)	20
Wing Fittings (T3515-T3572).....	21
Wing Fittings Continued (T3515-T3572).....	22
Wing Fittings Continued (T3515-T3572).....	23
Z-Fittings (T3603-T3612).....	24
Clamping Nut Product Variables	25
Clamping Nuts (T4002-4402)	25
Hardware Product Variables	26
U-Bolts (T5021-T5148)	26
J-Hooks & Eye Bolt (T5200-T5640).....	27
Miscellaneous Product Variables	28

The specifications in this document are for reference only and are subject to change without prior notice.

TABLE OF CONTENTS

Miscellaneous (T6000-T6200).....	28
Post Base Product Variables	29
Post Bases (T7030-T7160).....	29
Beam Clamp Product Variables.....	30
Window Beam Clamps (T8010 & T8011)	30
C-Style Beam Clamps (T8020-T8022).....	30
Strut Beam Clamps (T8030-T8050)	31
J-Hook Beam Clamps (T8100-T8110).....	31
U Bolt Beam Clamps (T8200 & T8201).....	32
Column Inserts (T8300 & T8301)	32
Center Beam Clamp (T8540-T8560).....	32
Safety Strap (T8600).....	32
Bracket & Brace Product Variables	33
Support Bracket (T9000/T9001)	33
Strut Bracket (T9106-T9136).....	33
Double Strut Bracket (T9206-T9236)	34
Cantilever Strut Bracket/Braced Cantilever Strut Bracket (T9308-T9338)	34
Shelf Bracket (T9408-T9420).....	35
Notched Strut Bracket (T9505-T9526).....	35
Offset Bracket (T9606-T9614).....	35
U-Shaped Back Plate – Strut Bracket (T9718/T9724)	36
Strut Brace(T9806-T9810).....	36
Strut Variables	37
Single, Double, and Slotted Strut (TS1310-TS3320).....	37

The specifications in this document are for reference only and are subject to change without prior notice.

T1000 SERIES: WASHERS

Washer Product Variables

Available Finishes / Product number Suffix (-XX):

- Hot Dip Galvanized (-HG) (Example: 1001-HG)
- Zinc / Electro-Galvanized (-ZC) (Example: 1001-ZC)
- Pre-Galvanized (-PG) (Example: 1001-PG)

Available Materials:

- Mild Steel
- 316 & 304 Stainless Steel (-SS) (Example: 1001-SS)

****Custom hole sizing and hole sizes not listed on relevant product charts can be made to order – please contact us for further details****

Strut Washers (T1001-T1016) (Pic with 9/16" hole)



1-1/2"x 1-1/2"		
Hole Diameter	Part Number	Approx Weight
5/16	T1001	0.154
7/16	T1002	0.149
9/16	T1003	0.142
11/16	T1004	0.133
13/16	T1005	0.123
15/16	T1006	0.111

1-5/8"x1-5/8"		
Hole Diameter	Part Number	Approx Weight
5/16	T1011	0.182
7/16	T1012	0.177
9/16	T1013	0.170
11/16	T1014	0.161
13/16	T1015	0.151
15/16	T1016	0.138

The specifications in this document are for reference only and are subject to change without prior notice.

T1000 SERIES: WASHERS

Square Washers (T1121 – T1148) (Pics with 9/16" Hole)



2"x 2"		
Hole Diameter	Part Number	Approx Weight
5/16	T1121	0.278
7/16	T1122	0.273
9/16	T1123	0.266
11/16	T1124	0.257
13/16	T1125	0.247



3"x 3"		
Hole Diameter	Part Number	Approx Weight
5/16	T1132	0.627
7/16	T1133	0.621
9/16	T1134	0.612
11/16	T1135	0.601
13/16	T1136	0.589
15/16	T1137	0.575



4"x 4"		
Hole Diameter	Part Number	Approx Weight
7/16	T1142-HG	1.124
9/16	T1143-HG	1.117
11/16	T1144-HG	1.108
13/16	T1145-HG	1.098
15/16	T1146-HG	1.086
1-1/16	T1147-HG	1.072
1-5/8	T1148-HG	1.039

The specifications in this document are for reference only and are subject to change without prior notice.

T1000 SERIES: WASHERS

No Twist Strut Washers (T1201-T1205) (Pics with 9/16" Hole)



1-5/8"x 1-5/8" - No Twist		
Hole Diameter	Part Number	Approx Weight
5/16	T1201	0.180
3/8	T1208	0.177
7/16	T1202	0.174
9/16	T1203	0.167
11/16	T1204	0.159
13/16	T1205	0.148

U-Washer (T1303) (Pic with 9/16" Hole)



1-5/8"x 1-5/8" - U-Washer		
Hole Diameter	Part Number	Approx Weight
9/16	T1303	0.616

The specifications in this document are for reference only and are subject to change without prior notice.

T2000 SERIES: PIPE & CONDUIT SUPPORTS

Pipe & Conduit Support Product Variables

Available Finishes / Product number Suffix (-XX):

- Hot Dip Galvanized (-HG) (Example: T2001-HG)
- Zinc / Electro-Galvanized (-ZC) (Example: T2001-ZC)
- Pre-Galvanized (-PG) (Example: T2001-PG)

Available Materials:

- Aluminum (-AL) (Example: 2001-AL)
- Mild Steel
- 316 & 304 Stainless Steel (-SS) (Example: T2001-SS)

Strut Clamps – Rigid (T2000-2008)



Rigid Strut Clamp				
Part Number	Gauge	Outside Diameter (In.)	Bolt Size	Load Capacity Lbs
T2000-1/4	14G	0.535"	1/4" x 1"	400
T2000-3/8	14G	0.675"	1/4" x 1"	400
T2000-1/2	14G	0.84"	1/4" x 1"	400
T2000-3/4	14G	1.05"	1/4" x 1"	600
T2001	14G	1.315"	1/4" x 1"	600
T2001-1/4	14G	1.66"	1/4" x 1"	600
T2001-1/2	14G	1.9"	1/4" x 1"	800
T2002	12G	2.375"	1/4" x 1"	800
T2002-1/2	12G	2.875"	1/4" x 1"	800
T2003	12G	3.5"	1/4" x 1-3/4"	800
T2003-1/2	12G	4"	1/4" x 1-3/4"	1000
T2004	12G	4.5"	1/4" x 1-3/4"	1000
T2005	12G	5.563"	3/8" x 1-3/4"	1000
T2006	11G	6.625"	3/8" x 1-3/4"	1000
T2008	11G	8.625"	3/8" x 1-3/4"	1000
T2000-10	11G	10.75"	3/8" x 1-3/4"	1000
T2000-12	11G	12.75"	3/8" x 2-1/2"	1000

The specifications in this document are for reference only and are subject to change without prior notice.

T2000 SERIES: PIPE & CONDUIT SUPPORTS

Strut Clamps – Thin Wall & OD (T2010-2028)



Thin Wall Conduit Strut Clamp				
Part Number	Gauge	Outside Diameter (In.)	Bolt Size	Load Capacity Lbs
T2010-3/8	14G	0.577"	1/4" x 1"	400
T2010-1/2	14G	0.706"	1/4" x 1"	400
T2010-3/4	14G	0.922"	1/4" x 1"	400
T2011	14G	1.163"	1/4" x 1"	600
T2011-1/4	14G	1.51"	1/4" x 1"	600
T2011-1/2	14G	1.74"	1/4" x 1"	800
T2012	12G	2.197"	1/4" x 1"	800



Outer Diameter (OD) Strut Clamp				
Part Number	Gauge	Outside Diameter (In.)	Bolt Size	Load Capacity Lbs
T2020-3/8	14G	0.375"	1/4" x 1"	400
T2020-1/2	14G	0.5"	1/4" x 1"	400
T2020-5/8	14G	0.625"	1/4" x 1"	400
T2020-3/4	14G	0.75"	1/4" x 1"	400
T2020-7/8	14G	0.8751"	1/4" x 1"	400
T2021	14G	1"	1/4" x 1"	600
T2021-1/4	14G	1.25"	1/4" x 1"	600
T2021-3/8	14G	1.375"	1/4" x 1"	600
T2022	12G	2"	1/4" x 1"	600
T2022-1/8	12G	2.125"	1/4" x 1"	800
T2022-1/4	12G	2.25"	1/4" x 1"	800
T2022-1/2	12G	2.5"	1/4" x 1"	800
T2023	12G	3"	1/4" x 1"	800
T2023-1/8	12G	3.125"	1/4" x 1"	800
T2023-1/4	12G	3.25"	1/4" x 1"	800
T2023-1/2	12G	3.5"	1/4" x 1-3/4"	800
T2023-5/8	12G	3.625"	1/4" x 1-3/4"	1000
T2024	12G	4"	1/4" x 1-3/4"	1000
T2024-3/8	12G	4.375"	1/4" x 1-3/4"	1000
T2024-1/2	12G	4.5"	1/4" x 1-3/4"	1000
T2024-5/8	12G	4.625"	1/4" x 1-3/4"	1000
T2025	12G	5"	1/4" x 1-3/4"	1000
T2026	11G	6"	3/8" x 1-3/4"	1000
T2027	11G	7"	3/8" x 1-3/4"	1000
T2028	11G	8"	3/8" x 1-3/4"	1000
T2020-10	11G	10"	3/8" x 2-1/2"	1000

The specifications in this document are for reference only and are subject to change without prior notice.

T2000 SERIES: PIPE & CONDUIT SUPPORTS

Pipe Block and Pipe Straps (T2100-2208)



Pipe Block		
Part Number	Usage	Approx. Weight
T2100	Useable with 2" - 8" Pipe	0.474

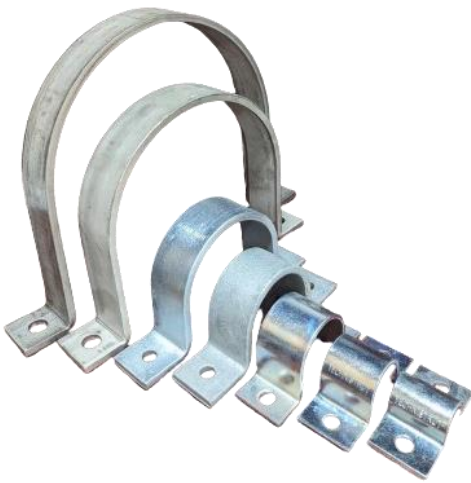

Pipe Strap			
Part Number	Inside Diameter (In.)	Approx. Weight	Load Capacity Lbs
T2200-1/2	0.5"	0.1812	500
T2200-3/4	0.75"	0.2732	500
T2201	1"	0.3115	500
T2201-1/4	1.25"	0.3645	500
T2201-1/2	1.5"	0.3948	500
T2202	2"	1.0781	1000
T2202-1/2	2.5"	1.2261	1000
T2203	3"	1.4116	1000
T2203-1/2	3.5"	1.5957	1000
T2204	4"	1.6938	1000
T2205	5"	2.0158	1000
T2206	6"	2.3223	1000
T2208	8"	2.9156	1200
T2200-10	10"	3.5303	1200

The specifications in this document are for reference only and are subject to change without prior notice.

T2000 SERIES: PIPE & CONDUIT SUPPORTS

Cable Clamps and Clevis Hangers (T2300-T2400)



Cable Clamp	
Part Number	Outside Diameter Range (In)
T2300-55	0.05" - 0.55"
T2300-81	0.31"-0.81"
T2301-1	0.61"-1.1"
T2301-35	0.85"-1.35"
T2301-75	1.25"-1.75"
T2300-05	1.55"-2.05"
T2300-50	2"-2.5"
T2303	2.5"-3"
T2303-25	2.75"-3.25"
T2303-75	3.25"-3.75"
T2304-25	3.75"-4.25"
T2304-75	4.25"-4.75"



Clevis Hangers	
Part Number	Pipe Size (in)
T2401	1"
T2401-1/4	1-1/4"
T2401-1/2	1-1/2"
T2402	2"
T2402-1/2	2-1/2"
T2403	3"
T2403-1/2	3-1/2"
T2404	

The specifications in this document are for reference only and are subject to change without prior notice.

T3000 SERIES: GENERAL FITTINGS

General Fitting Product Variables

Available Finishes / Product number Suffix (-XX):

- Hot Dip Galvanized (-HG) (Example: 3012-HG)
- Zinc / Electro-Galvanized (-ZC) (Example: 3012-ZC)
- Pre-Galvanized (-PG) (Example: 3012-PG)

Available Materials:

- Mild Steel
- 316 & 304 Stainless Steel (-SS) (Example: 3012-SS)

90 Degree Fittings (T3012-T3092)

Standard Dimensions (Unless specified otherwise)			
Hole Spacing (From End)	Hole Spacing (On-Center)	Hole Diameter	Thickness (in)
13/16	1-7/8	9/16	1/4



T3012 : 2 Hole Angle
1-5/8" x 2-1/4"



T3013 : 3 Hole Angle
1-5/8" x 4-1/8"



T3013-A : 3 Hole Angle
2-1/4" x 3-1/2"



T3014 : 4 Hole Angle
3-1/2" x 4-1/8"



T3023 : 3 Hole Wide Angle
1-5/8 x 3-1/2" x 2-1/4"



T3024 : 4 Hole Wide Angle
1-5/8 x 3-1/2" x 4-1/8"

The specifications in this document are for reference only and are subject to change without prior notice.

T3000 SERIES: GENERAL FITTINGS

90 Degree Fittings Continued (T3012-T3092)

Standard Dimensions (Unless specified otherwise)			
Hole Spacing (From End)	Hole Spacing (On-Center)	Hole Diameter	Thickness (in)
13/16	1-7/8	9/16	1/4



T3024-A : 4 Hole Wide Angle
1-5/8" x 3-1/4" x 2-1/4"



T3025 : 5 Hole Wide Angle
1-5/8" x 5-3/8" x 4-1/8"



T3032 : 2 Hole Corner Angle
1-7/8" x 2"



T3033 : 3 Hole Corner Angle
1-7/8" x 3-7/8"



**T3034 : 4 Hole Corner Angle
With Gusset**
4" x 4"



**T3044-LI : 4 Hole Corner Angle
Left Inside**
1-5/8" x 3-1/2" x 4-1/8"



**T3044-RI : 4 Hole Corner Angle -
Right Inside**
1-5/8" x 3-1/2" x 4-1/8"



**T3044-LO : 4 Hole Corner
Angle - Left Outside**
1-7/8" x 3-1/2" x 3-7/8"



**T3044-RO : 4 Hole Corner
Angle - Right Outside**
1-7/8" x 3-1/2" x 3-7/8"

The specifications in this document are for reference only and are subject to change without prior notice.

T3000 SERIES: GENERAL FITTINGS

90 Degree Fittings Continued (T3012-T3092)

Standard Dimensions (Unless specified otherwise)			
Hole Spacing (From End)	Hole Spacing (On-Center)	Hole Diameter	Thickness (in)
13/16	1-7/8	9/16	1/4





		
T3054 : 4 Hole Tee Angle 2" x 5-3/8"	T3055 : 5 Hole Tee Angle 2" x 5-3/8" x 3-1/2"	T3073 : 2 Hole Offset Angle 1-7/8" x 3"
		
T3073-1/2 : 2 Hole Offset Angle 1-7/8" x 3-1/2"	T3074 : 2 Hole Offset Angle 1-7/8" x 4"	T3084 : Slotted Angle 1-7/8" X 4-7/8"
		
T3086 : Slotted Angle 1-7/8" X 6-7/8"	T3092 : 2 Hole No Twist Angle 2-1/8"	T3025-A : 5 Hole Angle 1-7/8" x 5-3/8" x 3-7/8"

The specifications in this document are for reference only and are subject to change without prior notice.

T3000 SERIES: GENERAL FITTINGS

Angular Fittings (T3102-T3134)

Standard Dimensions (Unless specified otherwise)			
Hole Spacing (From End)	Hole Spacing (On-Center)	Hole Diameter	Thickness (in)
13/16	1-7/8	9/16	1/4

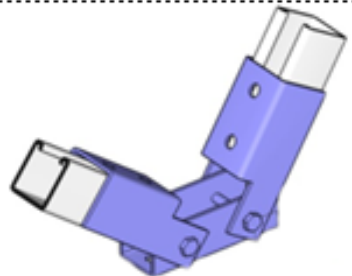
					
T3102 : 2 Hole Open Angle Available angles: 30°, 45°, 60°		T3104 : 4 Hole Open Angle Available angles: 30°, 45°, 60°		T3112 : 2 Hole Closed Angle Available angles: 30°, 45°, 60°	
Dimensions		Dimensions		Dimensions	
T3102-30	2-1/16" x 3-1/4"	T3104-30	3-1/2" x 3-11/16"	T3112-30	2-1/2" x 3"
T3102-45	2-5/16" x 3"	T3104-45	3-1/2" x 3-11/16"	T3112-45	2-1/2" x 3-1/8"
T3102-60	1-7/8" x 3-3/8"	T3104-60	3-1/2" x 3-11/16"	T3112-60	2-1/2" x 3-1/8"
					
T3114 : 4 Hole Closed Angle Available angles: 30°, 45°, 60°		T3120 : Single Adjustable Brace Fitting		T3125 : Double Adjustable Brace Fitting	
Dimensions					
T3112-30	3-1/2" x 3-11/16"				
T3112-45	3-1/2" x 3-11/16"				
T3112-60	3-1/2" x 3-11/16"				

The specifications in this document are for reference only and are subject to change without prior notice.

T3000 SERIES: GENERAL FITTINGS

End Caps for Strut (T3200-T3210)

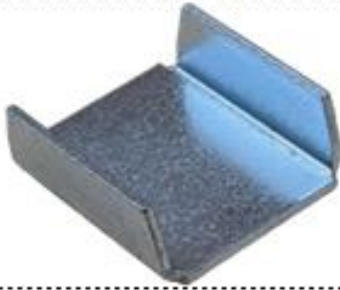

T3200 :End Cap for 1-5/8" Strut

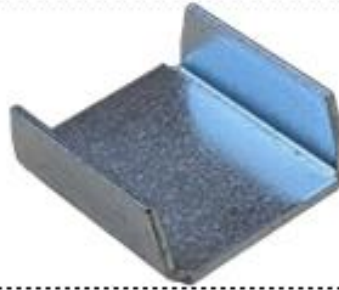

**T3200-13/16 :End Cap for 13/16
Strut**

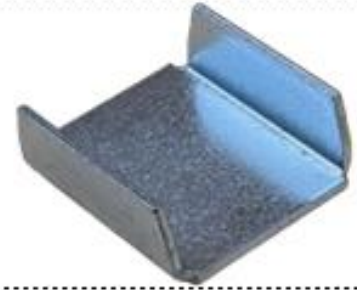

T3200-1 :End Cap for 1" Strut



**T3210 :End Cap with 3/4"
Knockout, 1-5/8" Strut**

The specifications in this document are for reference only and are subject to change without prior notice.

T3000 SERIES: GENERAL FITTINGS

Flat Plate Fittings (T3302-T3380)

Standard Dimensions (Unless specified otherwise)			
Hole Spacing (From End)	Hole Spacing (On-Center)	Hole Diameter	Thickness (in)
13/16	1-7/8	9/16	1/4









		
T3302 : 2 Hole Splice Plate 1-5/8" x 3-1/2"	T3302-A : 2 Hole Splice Plate 1-5/8" x 3-1/4"	T3304 : 4 Hole Splice Plate 1-5/8" x 4-1/4"
		
T3313 : 3 Hole Crossing Plate 1-5/8" x 4-7/8"	T3313-A : 3 Hole Crossing Plate 1-5/8" x 5-3/8"	T3315 : 5 Hole Crossing Plate 1-5/8" x 9-1/8"
		
T3333: 3 Hole Corner Plate 3-1/2" x 3-1/2"	T3334: 4 Hole Corner Plate 3-1/2" x 5-3/8"	T3343: 3 Hole Wide Corner Plate 3-1/2" x 3-1/2"

The specifications in this document are for reference only and are subject to change without prior notice.

T3000 SERIES: GENERAL FITTINGS

Flat Plate Fittings Continued (T3302-T3380)

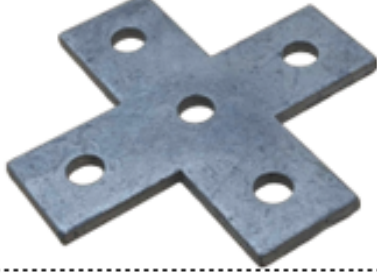
Standard Dimensions (Unless specified otherwise)			
Hole Spacing (From End)	Hole Spacing (On-Center)	Hole Diameter	Thickness (in)
13/16	1-7/8	9/16	1/4

		
T3344: 4 Hole Wide Corner Plate 3-1/2" x 5-3/8"	T3345: 5 Hole Wide Corner Plate 5-3/8 x 5-3/8"	T3354: 4 Hole Tee Plate 5-3/8" x 3-1/2"
		
T3363: 3 Hole Wide Tee Plate 3-1/2" x 3-1/2"	T3364: 4 Hole Wide Tee Plate 3-1/2" x 5-3/8"	T3365: 5 Hole Wide Tee Plate 5-3/8 x 5-3/8"
		
T3366: 6 Hole Wide Tee Plate 3-1/2 x 9-1/8"	T3370: 5 Hole Cross Plate 5-3/8 x 5-3/8"	T3380: 3 Hole Adjustable Angle Plate - 1-5/8" x 7-1/8" T3380-A: 2 Hole Adjustable Angle Plate - 1-5/8" x 5-1/4"

The specifications in this document are for reference only and are subject to change without prior notice.

T3000 SERIES: GENERAL FITTINGS

U-Fittings (T3402-T3480)

Standard Dimensions (Unless specified otherwise)			
Hole Spacing (From End)	Hole Spacing (On-Center)	Hole Diameter	Thickness (in)
13/16	1-7/8	9/16	1/4



T3402 : 2 Hole U-Splice
13/16" Strut



T3403 : 3 Hole U-Splice
1-5/8" Strut



T3404 : 4 Hole U-Splice
1-5/8" Strut



T3404-A : 4 Hole U-Splice
1-5/8" Strut



T3404-13/16 : 4 Hole U-Splice
13/16" Strut



T3404-3-1/4 : 4 Hole U-Splice
3-1/4" Strut



T3410 : Crossing U-Fitting
1-5/8" Strut



T3410-13/16 : Crossing U-Fitting
13/16" Strut



T3410-1 : Crossing U-Fitting
1" Strut

The specifications in this document are for reference only and are subject to change without prior notice.

T3000 SERIES: GENERAL FITTINGS

U-Fittings Continued (T3400-T3480)

Standard Dimensions (Unless specified otherwise)			
Hole Spacing (From End)	Hole Spacing (On-Center)	Hole Diameter	Thickness (in)
13/16	1-7/8	9/16	1/4



T3410-2-7/16 : Crossing U-Fitting
2-7/16" Strut



T3410-3-1/4 : Crossing U-Fitting
3-1/4" Strut



T3420 : Wide Crossing U-Fitting
1" Strut

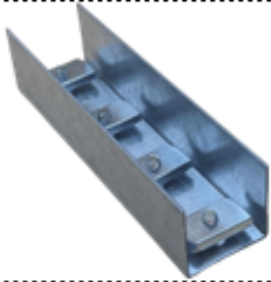

T3470 : U-Splice With Hardware
1-5/8" Strut



T3470-13/16 : U-Splice With Hardware
13/16" Strut

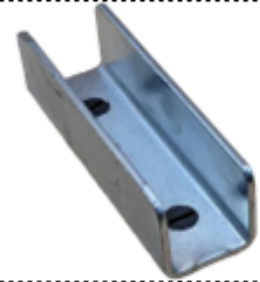







T3480 : Inside U Splice
1-5/8" Strut

The specifications in this document are for reference only and are subject to change without prior notice.

T3000 SERIES: GENERAL FITTINGS

Wing Fittings (T3515-T3572)

Standard Dimensions (Unless specified otherwise)			
Hole Spacing (From End)	Hole Spacing (On-Center)	Hole Diameter	Thickness (in)
13/16	1-7/8	9/16	1/4

		
T3515 : 5 Hole Crossing Wing	T3518 : 8 Hole Crossing Wing	T3510 : 10 Hole Crossing Wing
		
T3532R : 2 Hole Corner Wing Right Hand	T3532L : 2 Hole Corner Wing Left Hand	T3533R : 3 Hole Corner Wing Right Hand
		
T3533L : 3 Hole Corner Wing Left Hand	T3534R : 4 Hole Corner Wing Right Hand	T3534L : 4 Hole Corner Wing Left Hand

The specifications in this document are for reference only and are subject to change without prior notice.

T3000 SERIES: GENERAL FITTINGS

Wing Fittings Continued (T3515-T3572)

Standard Dimensions (Unless specified otherwise)			
Hole Spacing (From End)	Hole Spacing (On-Center)	Hole Diameter	Thickness (in)
13/16	1-7/8	9/16	1/4



**T3534R-A : 4 Hole Corner Wing
Right Hand**



**T3534L-A : 4 Hole Corner Wing
Left Hand**



T3544: 4 Hole Dual Corner Wing



T3546: 6 Hole Dual Corner Wing



T3548: 8 Hole Dual Corner Wing



**T3548-A: 8 Hole Dual Corner
Wing with Gusset**



**T3548-B: 8 Hole Dual Corner
Wing with Gusset**



T3556: 6 Hole 3-Way Fitting



T3559: 9 Hole 3-Way Fitting

The specifications in this document are for reference only and are subject to change without prior notice.

T3000 SERIES: GENERAL FITTINGS

Wing Fittings Continued (T3515-T3572)

Standard Dimensions (Unless specified otherwise)			
Hole Spacing (From End)	Hole Spacing (On-Center)	Hole Diameter	Thickness (in)
13/16	1-7/8	9/16	1/4

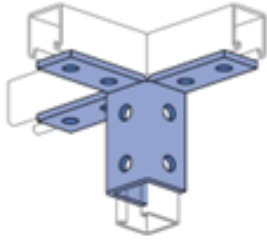

T3552: 9 Hole 3-Way Fiting



T3552-A: 12 Hole 3-Way Fitting with Gusset



T3572R: 2 Hole Rear Wing Right Hand



T3572L: 2 Hole Rear Wing Left Hand

The specifications in this document are for reference only and are subject to change without prior notice.

T3000 SERIES: GENERAL FITTINGS

Z-Fittings (T3603-T3612)

Standard Dimensions (Unless specified otherwise)			
Hole Spacing (From End)	Hole Spacing (On-Center)	Hole Diameter	Thickness (in)
13/16	1-7/8	9/16	1/4

		
<p>T3603 : 3 Hole Z-Fitting 1-5/8"</p>	<p>T3603-13/16 : 2 Hole Z-Fitting 13/16"</p>	<p>T3603-1 : 2 Hole Z-Fitting 1"</p>
		
<p>T3603-2-7/16 : 2 Hole Z-Fitting 2-7/16"</p>	<p>T3612 : 2 Hole Splice 1/4" Offset</p>	

The specifications in this document are for reference only and are subject to change without prior notice.

T4000 SERIES: CLAMPING NUTS

Clamping Nut Product Variables

Available Finishes / Product number Suffix (-XX):

- Hot Dip Galvanized (-HG) (Example: 4002-HG)
- Zinc / Electro-Galvanized (-ZC) (Example: 4002-ZC)
- Pre-Galvanized (-PG) (Example: 4002-PG)

Available Materials:

- Mild Steel
- 316 & 304 Stainless Steel (-SS) (Example: 4002-SS)

Clamping Nuts (T4002-4402)



No Spring	
Part Number	Thread Size
T4002	3/8"
T4004	5/8"
T4006	3/4"

Regular Spring		
Part Number	Thread Size	Spring Length
T4101	1/4"	1.5"
T4102	3/8"	1.5"
T4103	1/2"	1.5"



Short Spring		
Part Number	Thread Size	Spring Length
T4202	3/8"	0.375"
T4203	1/2"	0.375"
T4204	5/8"	0.375"

Long Spring		
Part Number	Thread Size	Spring Length
T4303	1/2"	2.875"



U-Shaped	
Part Number	Thread Size
T4303	1/2"

The specifications in this document are for reference only and are subject to change without prior notice.

T5000 SERIES: HARDWARE

Hardware Product Variables

Available Finishes / Product number Suffix (-XX):

- Hot Dip Galvanized (-HG) (Example: 5021-HG)
- Zinc / Electro-Galvanized (-ZC) (Example: 5021-ZC)
- Pre-Galvanized (-PG) (Example: 5021-PG)

Available Materials:

- Mild Steel
- 316 & 304 Stainless Steel (-SS) (Example: 5021-SS)

U-Bolts (T5021-T5148)

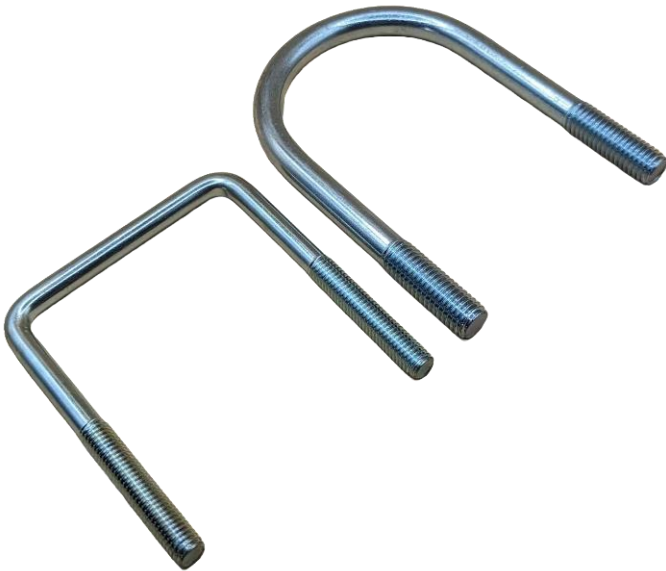

Round Head U-Bolt			
Part Number	Thread Size	Width	Length
T5021	5/16	1-1/2"	3"
T5022	5/16	1-3/4"	3"
T5023	5/16	3"	4-1/8"
T5041	3/8	2"	3-1/4"
T5042	3/8	4-1/2"	5-1/2"
T5051	1/2	3"	8"
T5052	1/2	4"	6"

Square Head U-Bolt			
Part Number	Thread Size	Width	Length
T5141	3/8	1-5/8"	3"
T5140	3/8	1-3/4"	3"
T5140-3.5	3/8	1-3/4"	4-1/8"
T5144	3/8	3-1/8"	3-1/4"
T5141	3/8	1-3/4"	5-1/2"
T5141-8.26	3/8	1-3/4"	8"
T5141-11	3/8	1-3/4"	6"
T5142	3/8	2-1/4"	4"
T5143	3/8	3"	4"
T5145	3/8	3-5/8"	4"
T5146	3/8	3-3/4"	8-1/4"
T5147	3/8	5-1/8"	9-1/4"
T5148	3/8	6-3/4"	9-1/2"

The specifications in this document are for reference only and are subject to change without prior notice.

T5000 SERIES: HARDWARE

J-Hooks & Eye Bolt (T5200-T5640)



J-Hook		
Part Number	Thread Size	Length
T5244	3/8	4"
T5248	3/8	7"
T5248-1/3	3/8	8-1/2"
T5240-10	3/8	10-1/2"
T5240-14	3/8	14"
T5256	1/2	5"
T5250-11	1/2	11"
T5250-14	1/2	14"



Eye Bolt			
Part Number	Thread Size	Inner Diameter	Length
T5640	3/8	1-1/8"	4"

The specifications in this document are for reference only and are subject to change without prior notice.

T6000: MISCELLANEOUS

Miscellaneous Product Variables

Available Finishes / Product number Suffix (-XX):

- Hot Dip Galvanized (-HG) (Example: 6000-HG)
- Zinc / Electro-Galvanized (-ZC) (Example: 6000-ZC)

Available Materials:

- Mild Steel
- 316 & 304 Stainless Steel (-SS) *For certain parts*(Example: 6000-SS)

Miscellaneous (T6000-T6200)

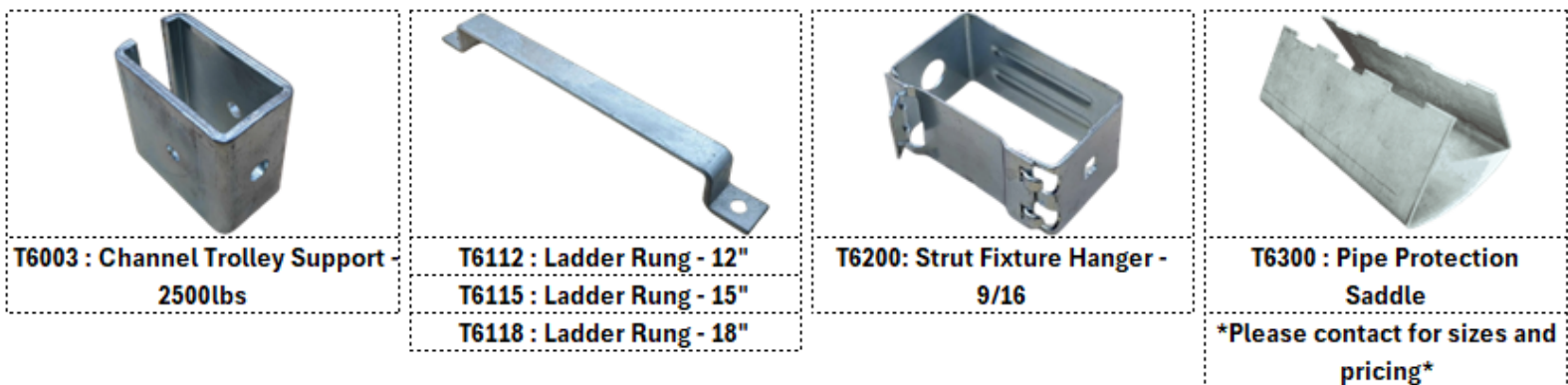

The specifications in this document are for reference only and are subject to change without prior notice.

T7000: POST BASES

Post Base Product Variables

Available Finishes / Product number Suffix (-XX):

- Hot Dip Galvanized (-HG) (Example: 7030-HG)
- Zinc / Electro-Galvanized (-ZC) (Example: 7030-ZC)

Available Materials:

- Mild Steel
- 316 & 304 Stainless Steel (-SS) (Example: 7030-SS)

Post Bases (T7030-T7160)

Single Post Base			
Part Number	Base Size	Channel Alignment	Channel Height
T7030-F	8x3	Flush	3-1/2"
T7040	4x6	Center	3-1/2"
T7040-F	4x6	Flush	3-1/2"
T7060	6x6	Center	3-1/2"
T7060-A	6x6	Center-45°	3-1/2"
T7061	6x6	Center	1-5/8"

Post Mount & Double Post Bases			
Part Number	Base Size	Channel Alignment	Channel Height
T7100	6x6	Center	3-1/2"
T7160	6x6	Center	3-1/2"
T7160	6x6	Center-45°	3-1/2"

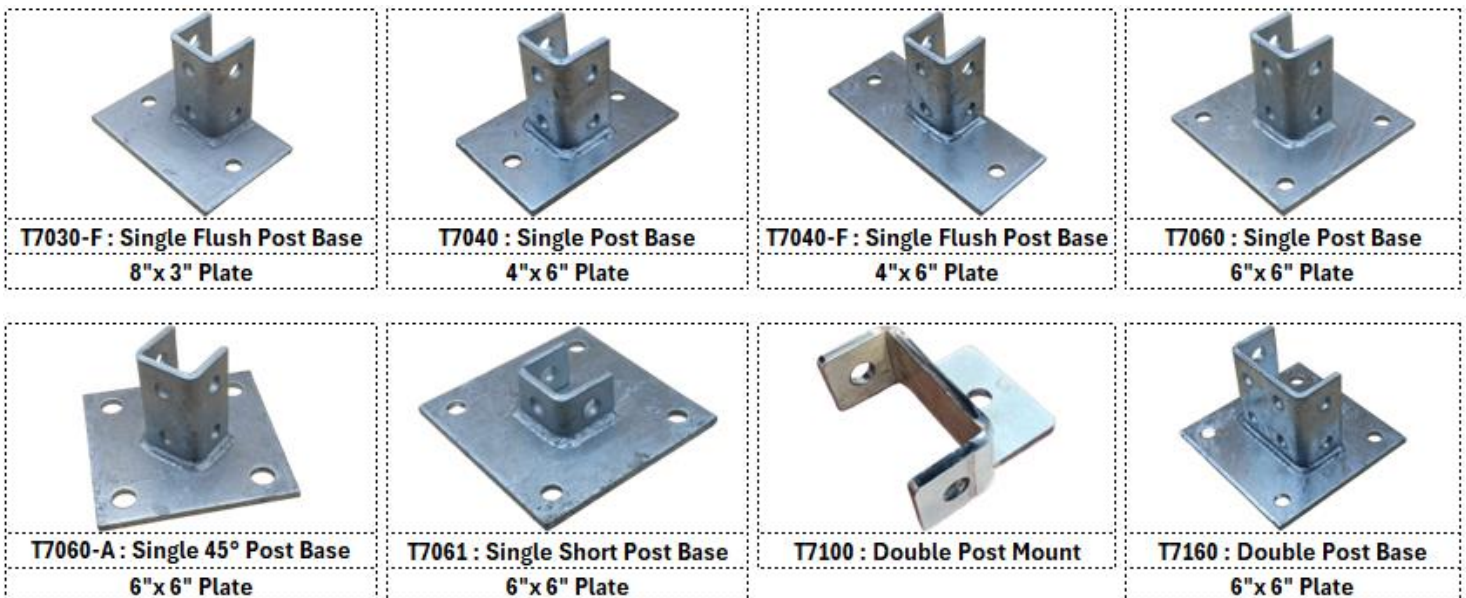

The specifications in this document are for reference only and are subject to change without prior notice.

T8000 SERIES: BEAM CLAMPS

Beam Clamp Product Variables



Available Finishes / Product number Suffix (-XX):

- Hot Dip Galvanized (-HG) (Example: 8020-HG)
- Zinc / Electro-Galvanized (-ZC) (Example: 8020-ZC)
- Pre-Galvanized (-PG) (Example: 8020-PG)

Available Materials:

- Mild Steel
- 316 & 304 Stainless Steel (-SS) (Example: 8020-SS)

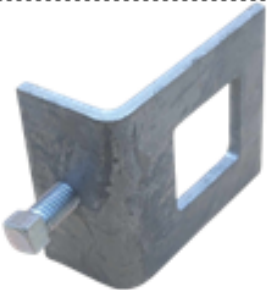
Window Beam Clamps (T8010 & T8011)

	
T8010 : Window Beam Clamp	T8011 : Double Window Beam Clamp
Beam Clamp Thickness up to 7/8"	Beam Clamp Thickness up to 7/8"
Design Load (LBS): 480	Design Load (LBS): 480

C-Style Beam Clamps (T8020-T8022)

C-Style			
Part Number	Opening Size	Thickness	Design Load Lbs
T8020	3/4"	1/8"	450
T8020-A	3/4"	3/8"	900
T8021	1"	1/4"	450
T8022-1/8	2-1/8"	3/8"	900
T8022-1/2	2-1/2"	3/8"	500

			
T8020 : C-Style Beam Clamp 3/4" Opening	T8020-A : C-Style Beam Clamp 3/4" Opening, 3/8" Thick	T8022-1/8 : C-Style Beam Clamp 2-1/8" Opening	T8022-1/2 : C-Style Beam Clamp 2-1/2" Opening

The specifications in this document are for reference only and are subject to change without prior notice.

T8000 SERIES: BEAM CLAMPS

Strut Beam Clamps (T8030-T8050)



T8030 : Z-Style Beam Clamp
Design Load (LBS): 600



T8040 : Flange Strut Beam Clamp
Design Load (LBS): 600



T8050-7/8 : Beam Clamp
7/8" Wide Mouth
Design Load (LBS): 500



T8050-7/8 : Beam Clamp
1-21/32" Wide Mouth
Design Load (LBS): 800

J-Hook Beam Clamps (T8100-T8110)

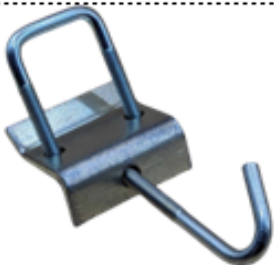

J-Hook Beam Clamp with U-Bolt

- T8100-7 : 7" J-Hook
- T8100-10 : 10" J-Hook
- T8100-14 : 14" J-Hook



J-Hook Beam Clamp with Deep U-Bolt

- T8101-7 : 7" J-Hook
- T8101-12 : 12.5" J-Hook
- T8101-14 : 14" J-Hook

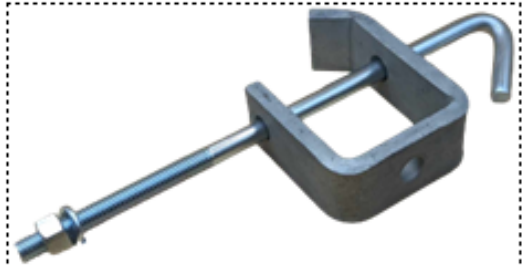

Hanger Beam Clamp with J-Hook

- T8110-11 : 11" J-Hook (800lbs load)
- T8110-19 : 19.5" J-Hook (800lbs load)

The specifications in this document are for reference only and are subject to change without prior notice.

T8000 SERIES: BEAM CLAMPS

U Bolt Beam Clamps (T8200 & T8201)



Column Inserts (T8300 & T8301)



Center Beam Clamp (T8540-T8560)

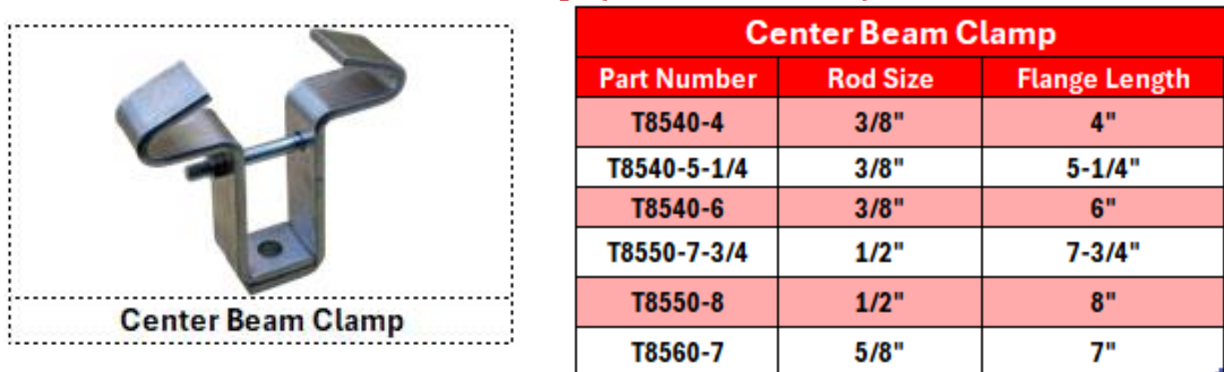

Safety Strap (T8600)

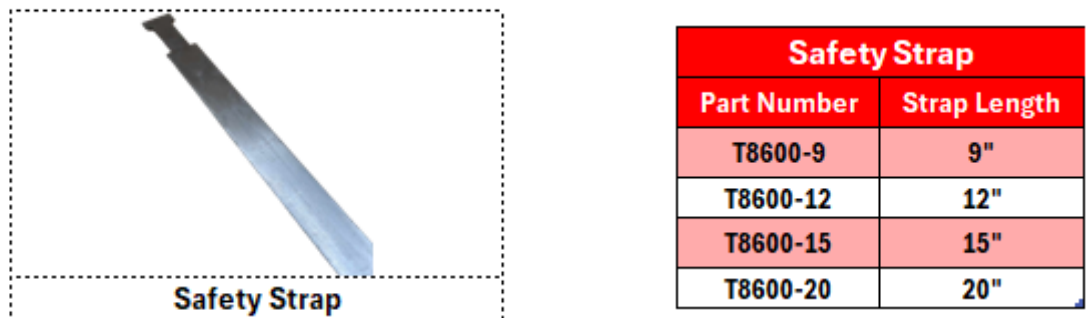

The specifications in this document are for reference only and are subject to change without prior notice.

T9000 SERIES: BRACKETS & BRACES

Bracket & Brace Product Variables

Available Finishes / Product number Suffix (-XX):

- Hot Dip Galvanized (-HG) (Example: 9000-HG)
- Zinc / Electro-Galvanized (-ZC) (Example: 9000-ZC)
- Pre-Galvanized (-PG) (Example: 9000-PG)

Available Materials:

- Mild Steel
- 316 & 304 Stainless Steel (-SS) (Example: 9000-SS)

Support Bracket (T9000/T9001)



Strut Bracket (T9106-T9136)



Strut Bracket		
Part Number	Strut Length	Load Capacity Lbs
T9106	6"	1400
T9107	7"	1100
T9112	12"	750
T9118	18"	500
T9124	24"	455
T9136	36"	265

Custom lengths available upon request

The specifications in this document are for reference only and are subject to change without prior notice.

T9000 SERIES: BRACKETS & BRACES

Double Strut Bracket (T9206-T9236)



Double Strut Bracket		
Part Number	Strut Length	Load Capacity Lbs
T9206	6"	2150
T9212	12"	1900
T9214	14"	1500
T9218	18"	1200
T9224	24"	930
T9230	30"	780
T9236	36"	610

Custom lengths available upon request

Cantilever Strut Bracket/Braced Cantilever Strut Bracket (T9308-T9338)



Cantilever Strut Bracket		
Part Number	Strut Length	Load Capacity Lbs
T9308	8"	2000
T9312	12"	2000
T9314	14"	2000
T9320	20"	1200
T9326	26"	975
T9332	32"	920
T9338	38"	860

Gusset included on sizes larger than 20"

Custom lengths available upon request

The specifications in this document are for reference only and are subject to change without prior notice.

T9000 SERIES: BRACKETS & BRACES

Shelf Bracket (T9408-T9420)



Shelf Bracket		
Part Number	Length	Load Capacity Lbs
T9408	8"	820
T9410	10"	820
T9412	12"	950
T9414	14"	950
T9416	16"	1150
T9418	18"	1090
T9420	20"	670

Custom lengths available upon request

Notched Strut Bracket (T9505-T9526)



Notched Strut Bracket		
Part Number	Strut Length	Load Capacity Lbs
T9508	8"	1100
T9514	14"	550
T9520	20"	350
T9526	26"	250

Custom lengths available upon request

Offset Bracket (T9606-T9614)



Offset Bracket		
Part Number	Inner Spacing	Hole to Hole Length
T9606	2-3/8"	6"
T9608	4-3/8"	8"
T9610	6-3/8"	10"
T9612	8-3/8"	12"
T9614	10-3/8"	14"

Custom lengths available upon request

The specifications in this document are for reference only and are subject to change without prior notice.

T9000 SERIES: BRACKETS & BRACES

U-Shaped Back Plate – Strut Bracket (T9718/T9724)

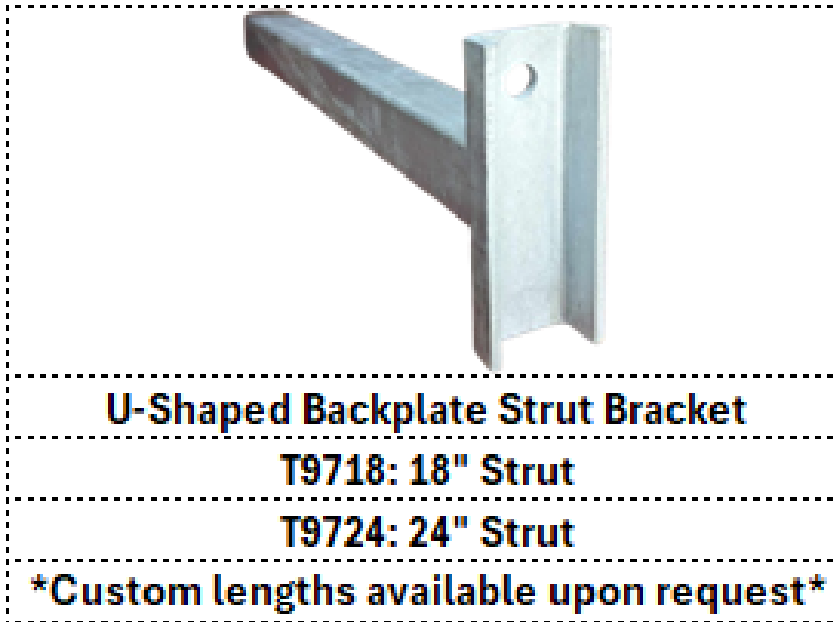

Strut Brace(T9806-T9810)



Strut Brace	
Part Number	Brace Length
T9806	6"
T9807	8"
T9808	12"
T9809	18"
T9810	24"

Custom lengths available upon request

The specifications in this document are for reference only and are subject to change without prior notice.

TS SERIES: STRUT LENGTH

Strut Variables

Available Finishes / Product number Suffix (-XX):

- Pre-Galvanized (-PG)

Available Materials:

- Mild Steel – Bare (-BR)
- 316 & 304 Stainless Steel (-SS/-SS4)

Custom Length Options – Please contact us for strut cut to custom length.

Single, Double, and Slotted Strut (TS1310-TS3320)



Single Channel Strut		
Part Number	Height	Length
TS1310	1-5/8"	10ft
TS1320	1-5/8"	20ft



Double Channel Strut		
Part Number	Height	Length
TS2310	1-5/8"	10ft
TS2320	1-5/8"	20ft



Slotted Channel Strut				
Part Number	Height	Length	Slot Sizing	Centers at
TS3310-1-1/8	1-5/8"	10ft	9/16" x 1-1/8"	2"
TS3320-1-1/8	1-5/8"	20ft	9/16" x 1-1/8"	2"

The specifications in this document are for reference only and are subject to change without prior notice.

TECHNISTRUT STRUT PRODUCTS



TECHNISTRUT MFG INC.
4145 LAWSON LINE
POSTAL CODE: N0B 2S0
PHONE: 519-698-9856
EMAIL: SALES@TECHNISTRUT.CA